



# LED FLEXIBLE NEON LIGHT SPECIFICATIONS

## >> PRODUCT CHARACTER



product model	TTK0410-144D
Voltage	DC12V/DC24V
Power	9.6W/Meter
Product size	4*10mm
CRI	≥80
Cutting length	2cm or 5cm
Waterproof Grade	IP67
Optional color	red,yellow, blue, green, white,warm-white, pink,ice-blue, orange,purple, lemon-yellow
Application	Cabinets \ furniture decorative lighting

## >> PRODUCT FEATURES

### 1.Product section

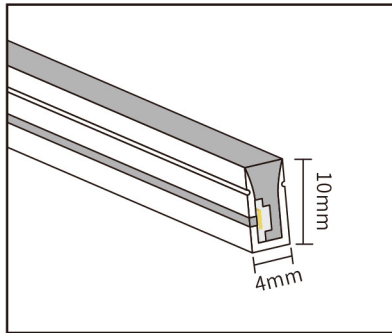

### 2.Maximum bending Angle

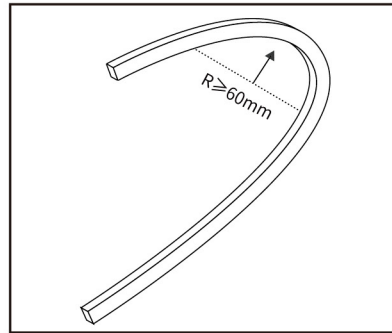

### 3.Luminous Angle

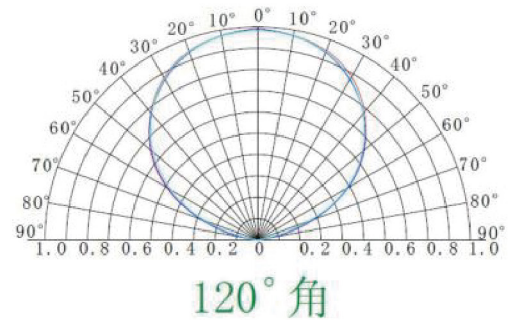

## >> INSTALLATION GUIDANCE

### 1..Cutting method and Coat with glue

(1)Crop at the black mark

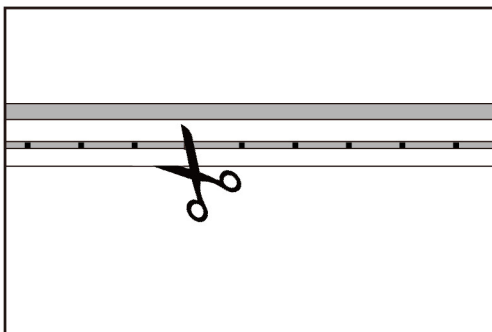

(2)Weld the positive and negative terminals to the electrode joints of the lamp strip with an electric rod solder

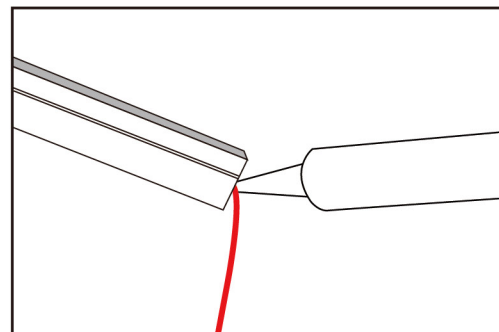



(3) Weld the positive and negative terminals to test whether the welding is correct

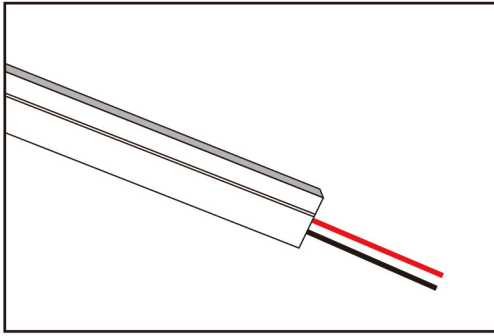

(4) Apply waterproof glue

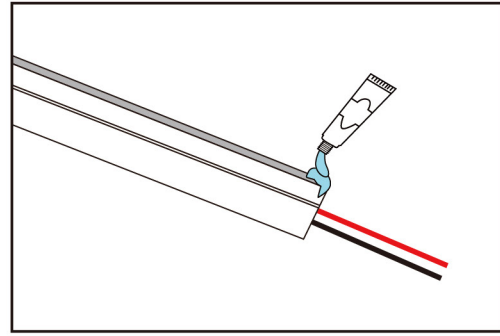

(5) put on protective cover

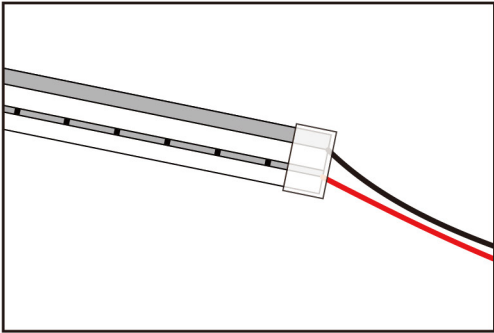

## 2. Bending direction

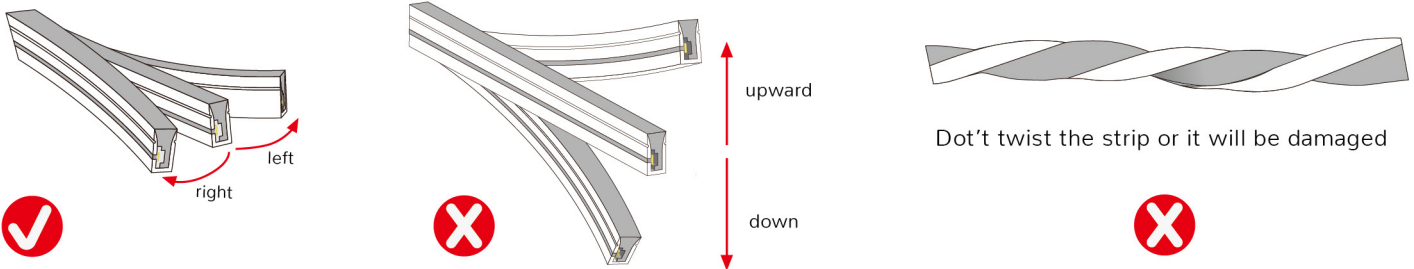

## 3. Features

- (1) The light source of the LED strip is 2835, which has high luminous efficiency, less heat, no mercury, and environmentally friendly performance;
- (2) Ultra-high-density arrangement of LED strips to create uniform and gentle light effect;
- (3) Low voltage DC12V/DC24V constant voltage driving to ensure safe and reliable running;
- (4) High light transmittance, environmental silicone material, integrated extrusion molding technology, IP67 waterproof.
- (5) Resistance to saline solutions, acids & alkali, corrosive gases and UV.
- (6) Working/Storage Temperature:  $T_a: -20 \sim 55^\circ\text{C} / 0^\circ\text{C} \sim 60^\circ\text{C}$
- (7) 2 years warranty, life span over 36000 hours.



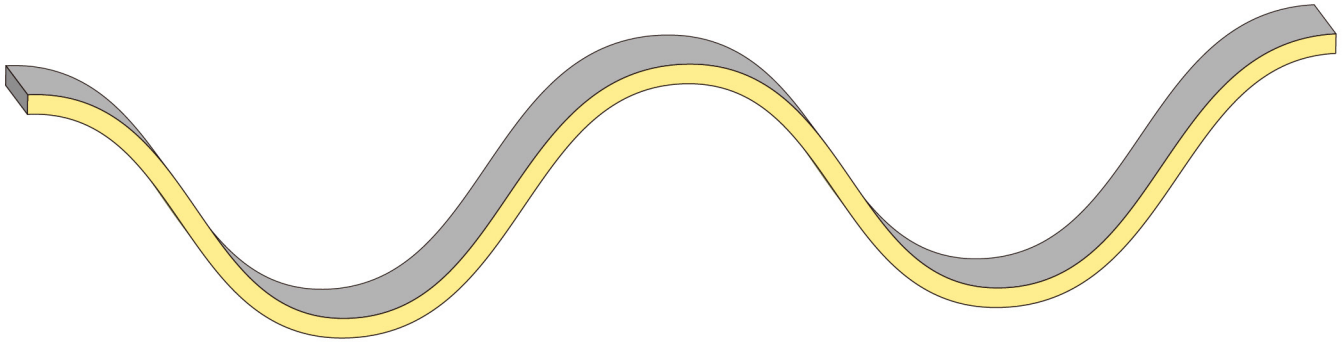

## >> Wiring installation diagram

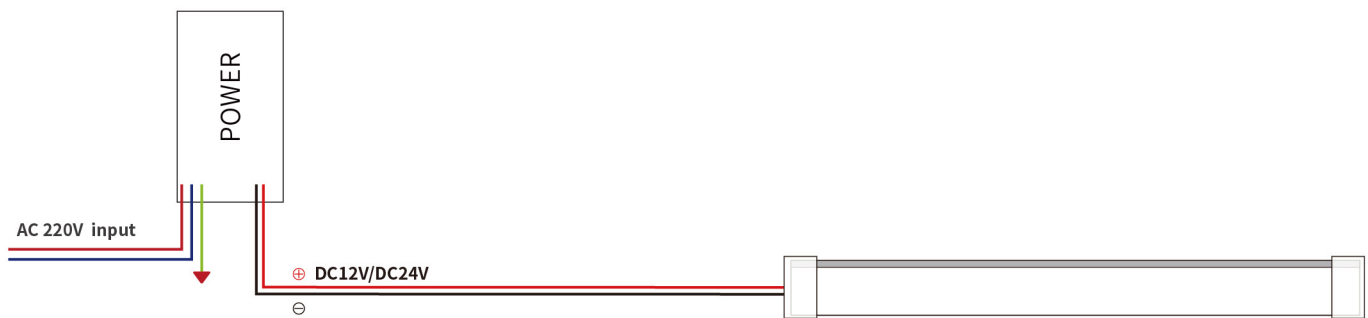

## >> WIRING DIAGRAM

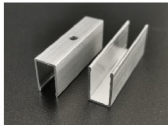

## >> ACCESSORY INFORMATION

Name	Packing	Image	Net weight per box (kg)
End cap without hole	1000pcs/bag		0.01kg
End cap with hole	1000pcs/bag		0.01kg
Aluminum clip	500pcs/bag		0.03kg



## >> APPLICATION

Home decoration (staircase lighting, hall aisle lighting, lighting decoration, edge hook decoration) Event venue decoration, exhibition venue decoration, exhibition hall decoration, show cases window, props and other decorative lighting applications, Linear light source and other applications.



## >> NOTE & WARNING

- ▲ In order to be able to better achieve the luminous effect of products, each 5 meters or 10 meters long lamp with a power connecting
- ▲ In order to ensure the lamp with long service life and the environment, can not force pulling the power line in these process, no collision so as not to damage the LED lamp.
- ▲ In order to ensure the lamp with life and reliability, please don't in the 60mm below diameter arc bending, not half so as not to damage the lamp or broken.
- ▲ Try to install the appropriate environment.
- ▲ Please note that careful operation, in the case of power on, don't hit the ac power, avoid shock.

## >> PACKAGING

