



LED FLEXIBLE NEON LIGHT SPECIFICATIONS

>> PRODUCT CHARACTER



product model	TTK-W1616
Voltage	DC24V
Power	16W/Meter
Product size	16*16mm
CRI	90
Waterproof Grade	IP65
Bead quantity	48LEDs/m
Lifespan (hours)	50000H@45°C
Working Temperature(°C)	-20 °C ~ 45°C
Luminous Angle	30°
DMX512	switch/dimmer
package	5m/roll

>> PRODUCT FEATURES

1.Product size

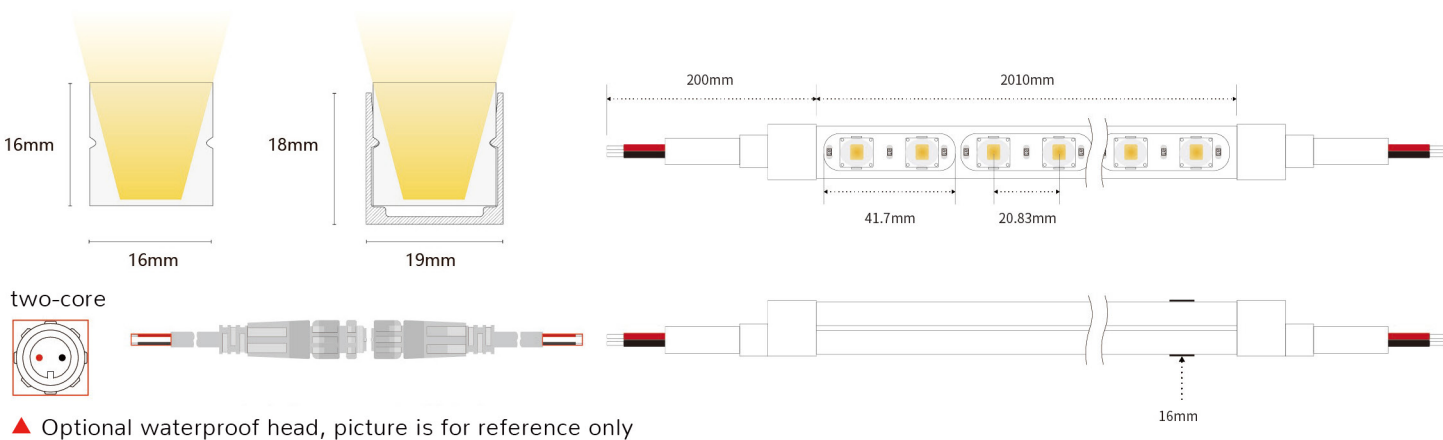

2.Light color parameter

(1) Optional color temperature lm/M

- 3000K 1550
- 4000K 1600
- 5000K 1630
- 6000K 1610
- R —
- G —
- B —
- RGBW —

(2) Distribution curve

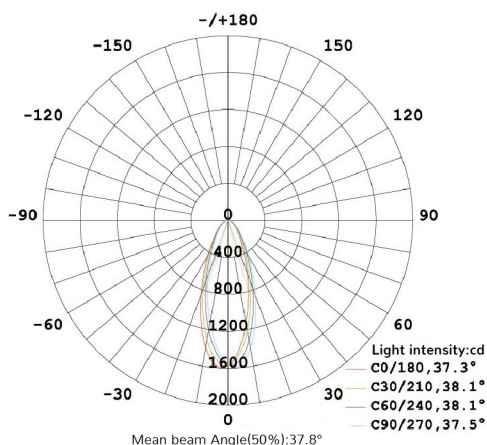

(3) Illuminance diagram(lx)

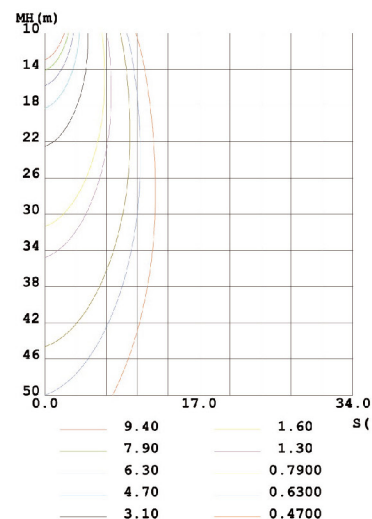



3..Features

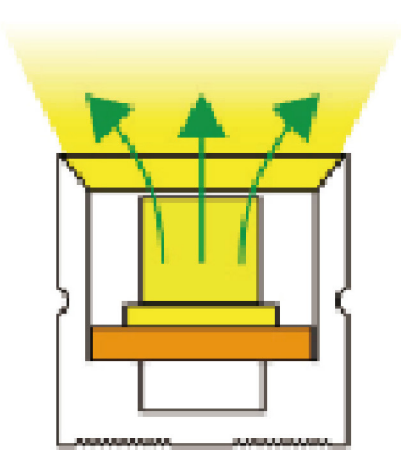

- ✧ (1) Optical lens light, to achieve different lighting requirements;
- ≡ (2) High flexibility, flexible modeling;
- ✂ (3) Silica gel two-color co-extrusion technology, cutting window design, easy to cut and use;
- 🔦 (4) Adopts module lens + silica gel design, can be positive bending side bending, 3D modeling;
- 🛡 (5) With good weather resistance, the neon strip can maintain a normal soft state when used within $-20^{\circ}\text{C}\sim+45^{\circ}\text{C}$, and will not appear embrittlement, deformation, softening, aging and other adverse conditions
- 🛡 (6) A variety of protection features, IP65 protection grade, salt solution resistance, acid and alkali resistance and anti-corrosion gas, fire resistance, UV resistance.

4.Bending direction

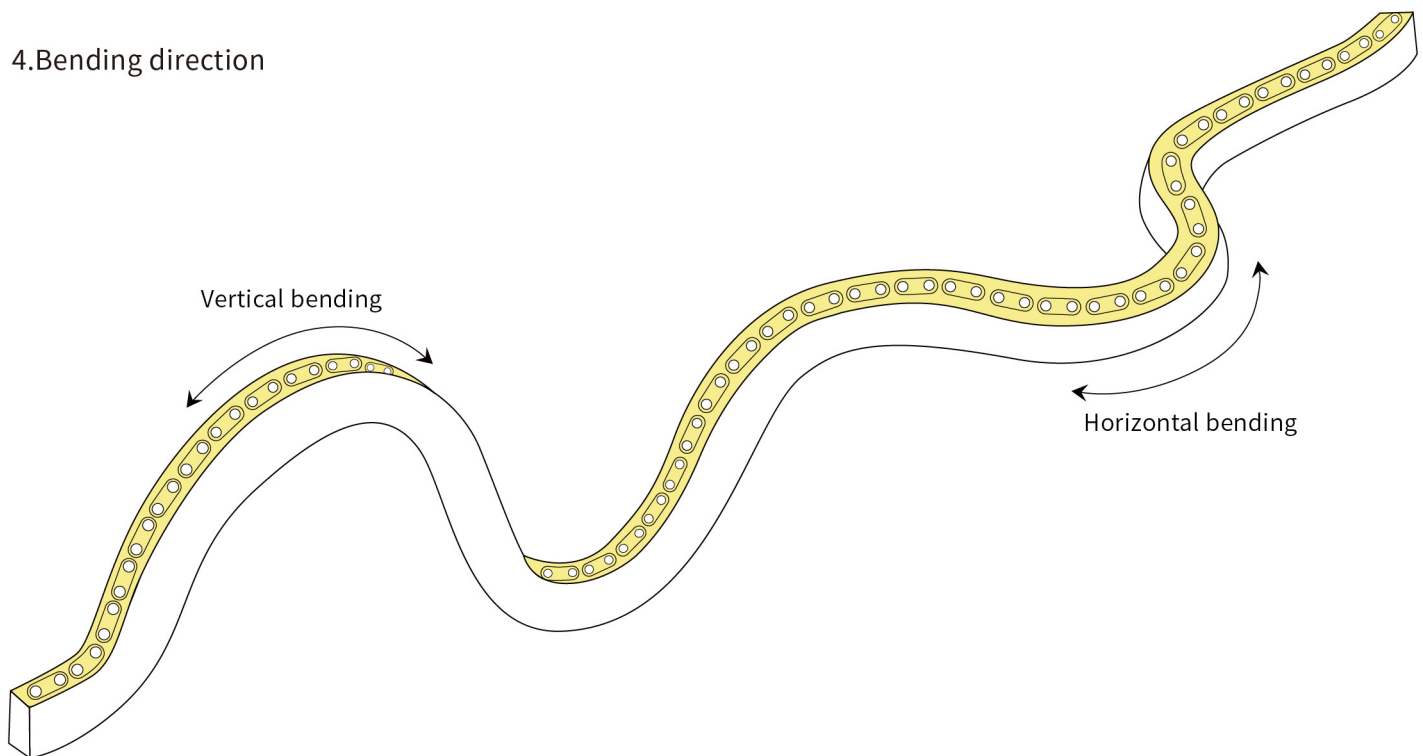

>> WIRING DIAGRAM

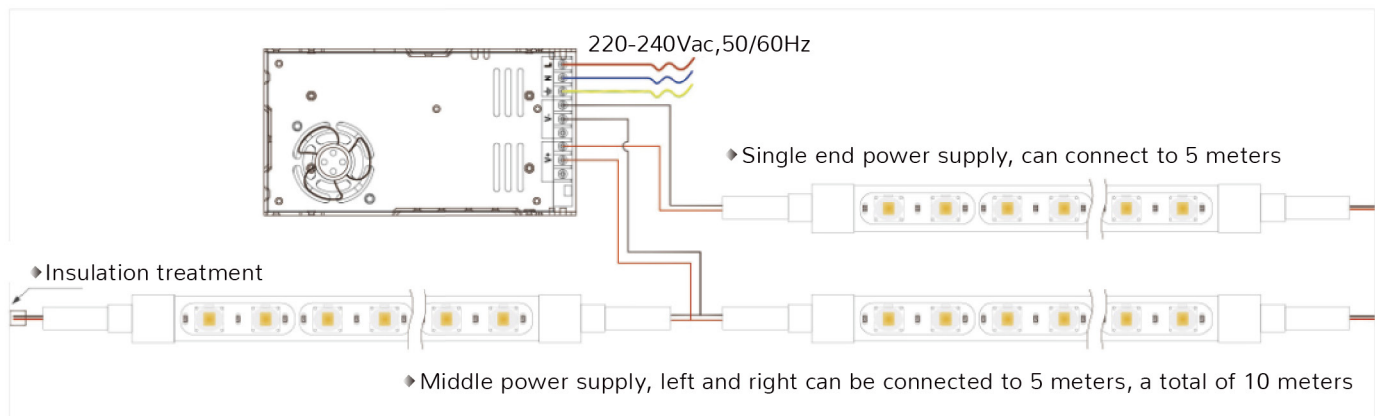



>> ACCESSORY INFORMATION

◆ The number of accessories can be freely matched by the customer



Tail end

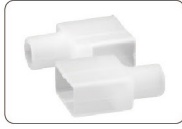

Positive outlet plug



Side outlet plug



No border plug

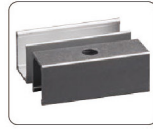

Aluminum card slot



screw



glue

◆ Aluminum list

	Product name	Product model	Sectional drawing	Install
	Aluminum card slot	19*18mm		
	Product name	Product model	Sectional drawing	Install
	3D flexible card slot	18*18mm		

>> APPLICATION

- ◆ Suitable for lighting projects, commercial places, subways, elevated overpasses, building exterior walls, building landmarks, and other interior and exterior wall panoramic flood lighting.
- ◆ Landscape building building, outdoor square. Landscape objects and wall, display painting. Can adapt to indoor and outdoor temperature and humidity environment





>> NOTE & WARNING

- ▲ 1. Please use 24VDC isolated power supply to drive the LED strip, and the ripple of the constant voltage source is less than 5%. Do not use resistance-capacitance step-down, non-isolated and other types of power supply to drive the LED strip.
- ▲ 2. In order to ensure the life and reliability of the lamp belt, please do not bend in the arc below 60mm diameter, do not fold in half to avoid damage to the lamp bead or fracture.
- ▲ 3. In order to ensure the life of the lamp belt and the use environment, the power cord can not be pulled forcefully during use, and the collision is prohibited to avoid damage to the LED lamp.
- ▲ 4. Pay attention to the positive and negative poles of the power cord during installation, do not connect wrong, and whether the voltage of the power supply is consistent with that of the product to avoid damage to the product.
- ▲ 5. The LED light belt should be stored in a dry and sealed environment. It is recommended that the storage period should not be too long. Please unseal before use. Operating temperature :-20°C~45°C.
Storage temperature :0°C~60°C, non-waterproof lamp belt please use indoors, relative humidity can not be higher than 70.
- ▲ 6. Please be careful. When the power is on, do not touch the AC power supply to prevent electric shock.
- ▲ 7. In practical applications, the power supply should retain 20% of the margin (it is recommended to use only 80% of the power) to ensure sufficient voltage to drive the product.
- ▲ 8. It is strictly prohibited to use any acidic or alkaline adhesive to fix the product (including but not limited to glass glue, etc.).

>> PACKAGING (weight:2kg/roll)

