

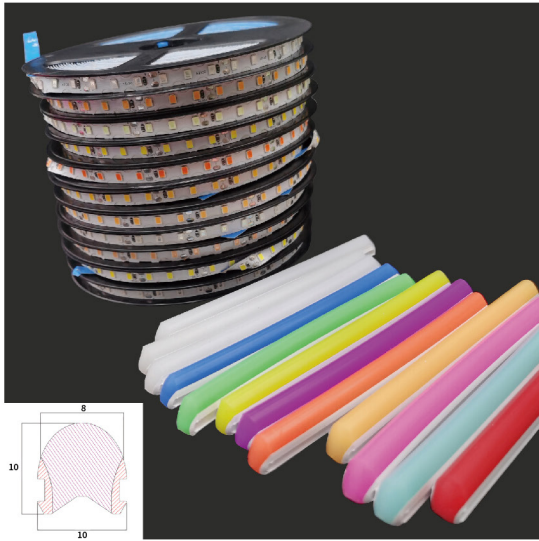

SILICONE SEPARATED NEON LIGHT SPECIFICATIONS

>> PRODUCT CHARACTER



product model	TTK-008
Voltage	DC5V/DC12V
Power	7W or 6W per Meter
Product size	8*10mm
CRI	≥80
Cutting length	2.5cm or 1cm
Waterproof Grade	IP20/IP43
Optional color	red,yellow, blue, green, white,warm-white, Pure-white, pink,Light-pink, ice-blue, orange, purple, lemon-yellow
Application	making neon signs

>> PRODUCT DETAILS

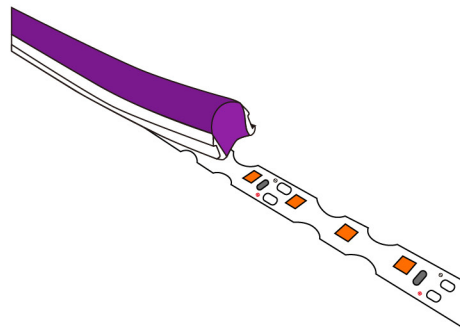
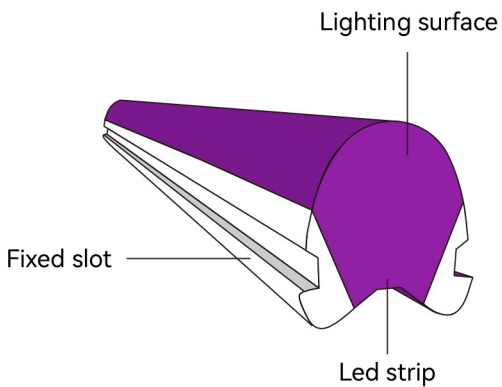

>> SPLIT MILLING CUTTER

Carving depth :4.2mm



Carving depth :5.8mm





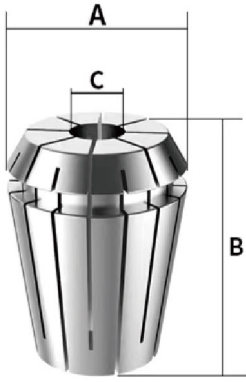

>> ACCESSORY INFORMATION

The following are the models available for collet selection

Picture	type	A	B	C
	ER11	11.5	18	1-7mm
	ER16	17	27.5	1-10mm
	ER20	21	31.5	1-13mm
	ER25	26	34	1-16mm
	ER32	33	40	1-20mm
	ER40	41	46	3-26mm

Name	Description	Image	Net weight per box (kg)
Cutter for silicone tube	Angle cutter tail cutter		0.1kg
5cm mini transparent connect wire (1000pcs per bag)	connector wire for led strip (custom Length)		0.05kg
6cm mini transparent connect wire (1000pcs per bag)			0.05kg
7cm mini transparent connect wire (1000pcs per bag)			0.05kg
10cm mini transparent connect wire (1000pcs per bag)			0.05kg
15cm mini transparent connect wire (1000pcs per bag)			0.05kg



>> THE DETAILS OF MAKING SIGN

1. Dig a groove with suitable milling cutter 2. Put in S-shape LED light

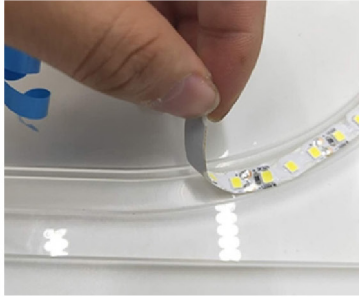
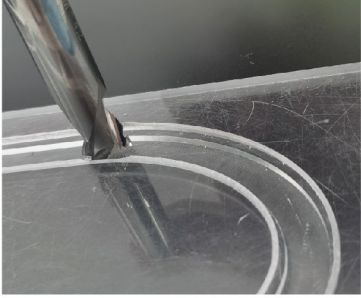

3. The S shape LED light between strokes is welded with the part connector 4. The silicone strip is embedded in the groove

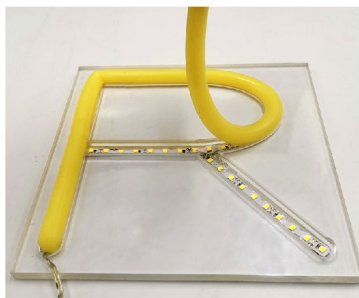
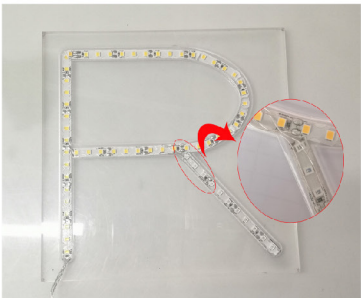

5. Cut the corner with an angle cutter, and cut the end of silicone with cap cutter

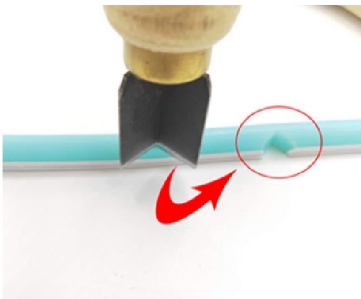

>> APPLICATION





>> PACKAGE

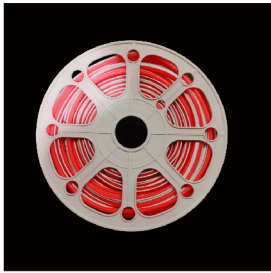

silicone tube
50m/roll



QTY:50m/roll*2
weight:10kg/box

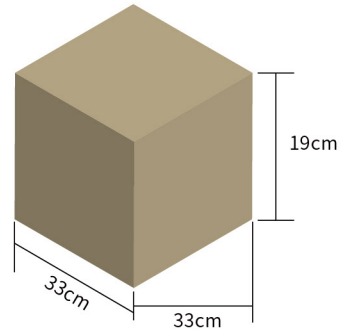

carton



LED strip with S shape
10m/roll



400m/box
weight:4.5kg/box

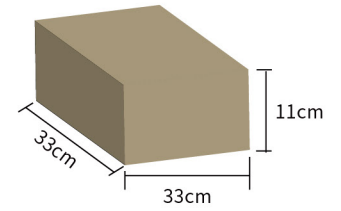

carton