

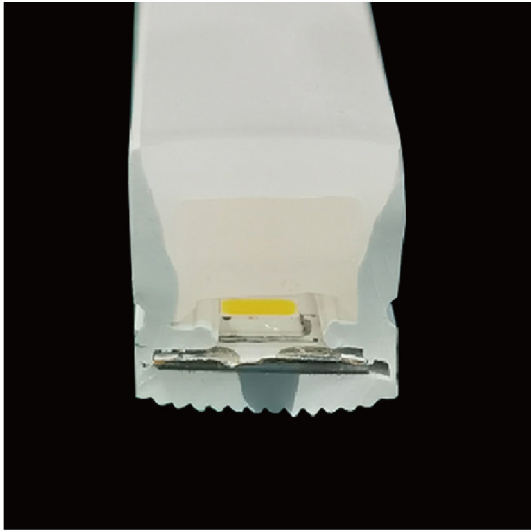

LED FLEXIBLE NEON LIGHT SPECIFICATIONS

>> PRODUCT CHARACTER



product model	TTK1212-120D
Voltage	AC220V/AC110V
Power	9W/Meter
Product size	12*12mm
CRI	≥80
Cutting length	10cm
Waterproof Grade	IP67
Optional color	3000K, 4000K, 6000K
Application	Signage lighting,Architectural contour lighting

>> PRODUCT FEATURES

1.Product section

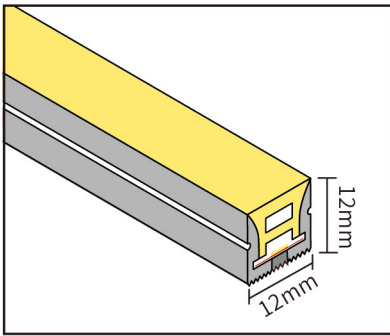

2.Maximum bending Angle

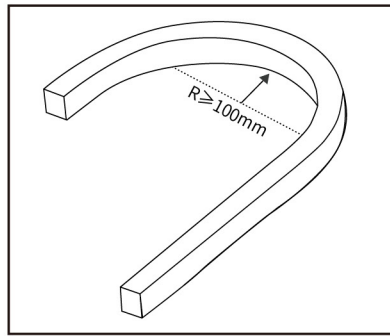

3.Luminous Angle

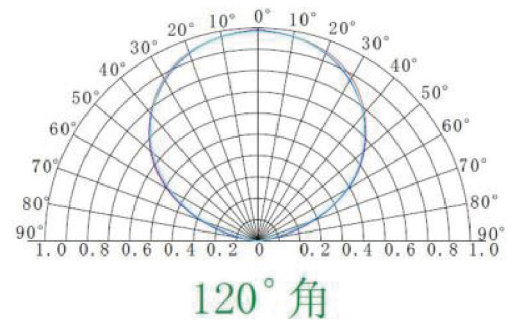

>> INSTALLATION GUIDANCE

1..Cutting method and Coat with glue

(1)Crop at the black mark

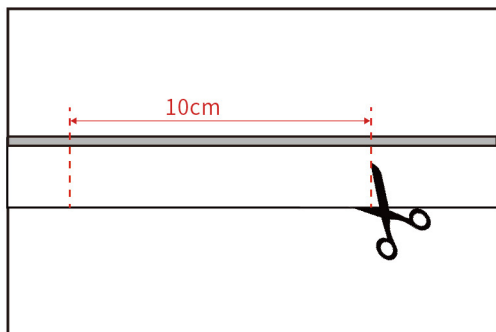

(2)Insert the pin tip into the light belt lead

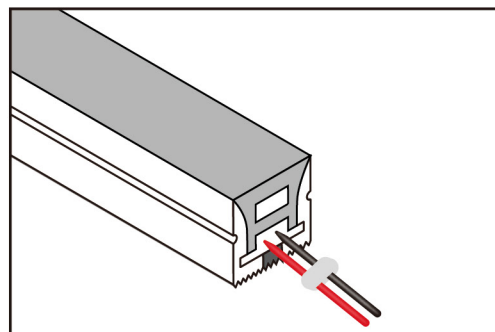



(3)Align the thick end of the pin with the power port and insert it firmly

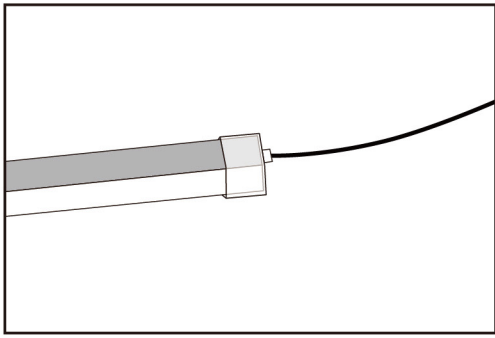

(4)The other end of the lamp belt is covered with a tail plug to prevent electric shock

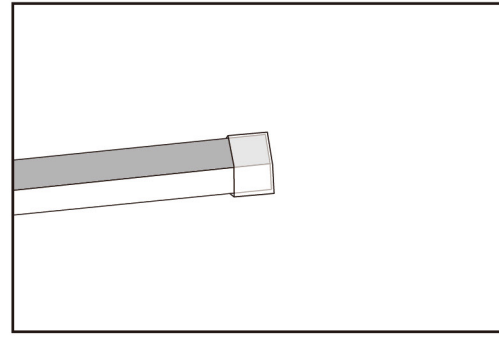

(5)Power test light attention to the positive and negative poles
(If the lamp belt is not bright, the power interface is pulled out and the 180° reverse side is connected to the lamp belt)

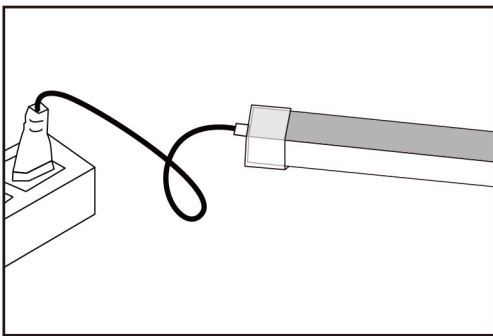

>> INSTALLATION GUIDANCE

1.Installation of clip

(1)Use screws to fix the clips or carriers on the mounting position

⚠ clip: 3 clips can be used for 1m

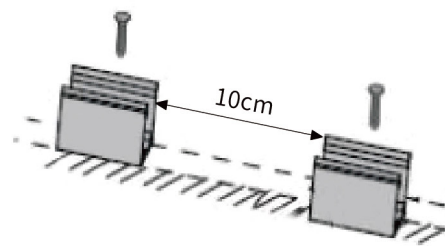
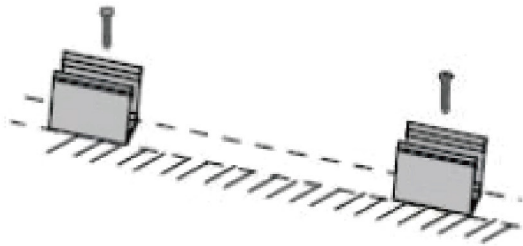

2.Installation of carring

(1)When installing the LED strip,install it from both ends at the same time,installation from one direction is prohibited.

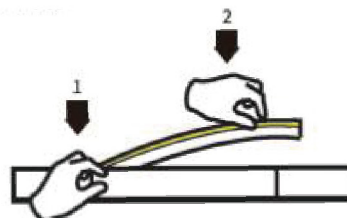
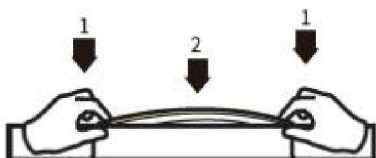



(2) Use tool to disassemble carefully, and do not pull the LED strip directly.

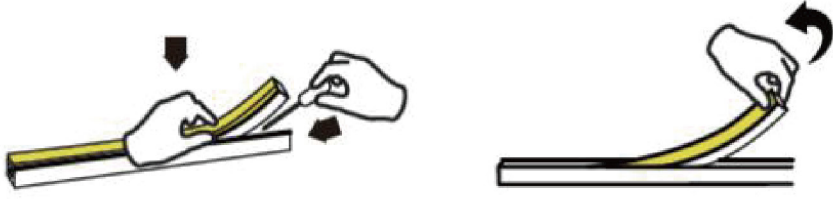

(3) If the length of LED strip is over 2m, it is recommended to install by two persons.

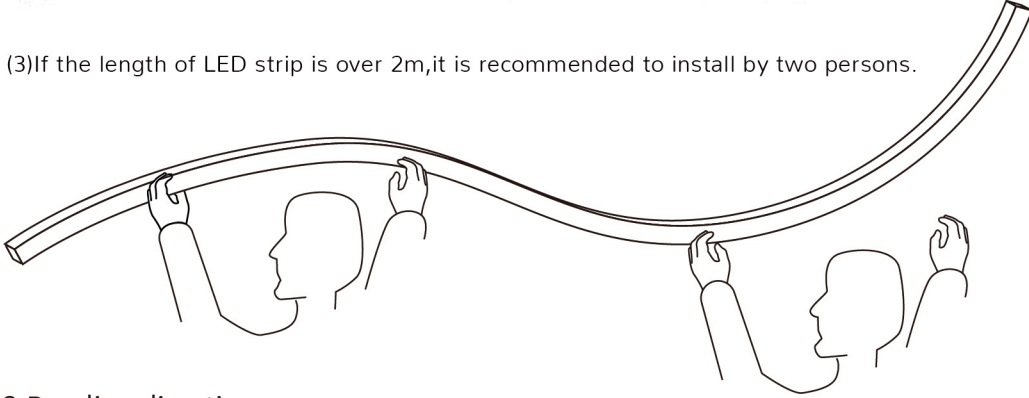

3. Bending direction

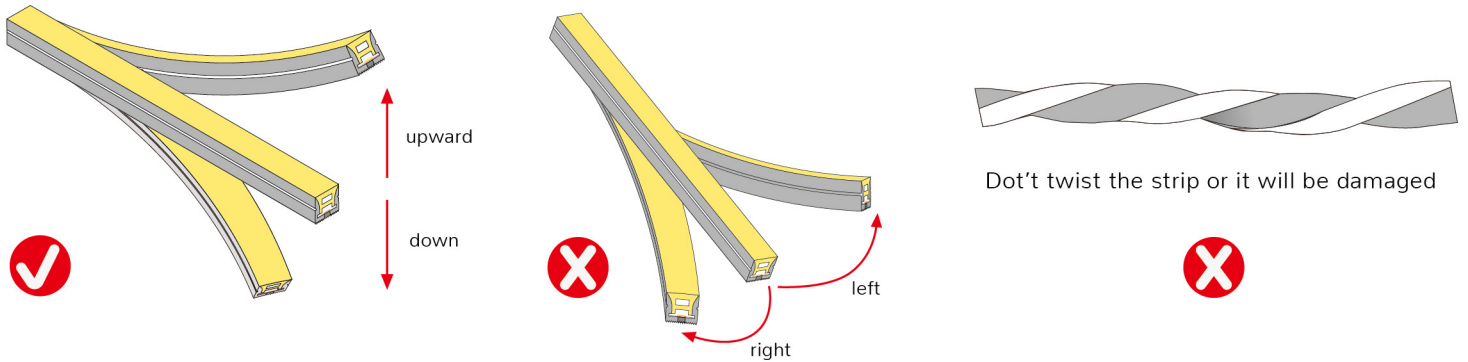

4. Features

- (1) The light source of the LED strip is 2835, which has high luminous efficiency, less heat, no mercury, and environmentally friendly performance;
- (2) Ultra-high-density arrangement of LED strips to create uniform and gentle light effect;
- (3) High pressure AC220V/AC110V constant voltage driving to ensure safe and reliable running;
- (4) High light transmittance, environmental silicone material, integrated extrusion molding technology, IP67 waterproof.
- (5) Resistance to saline solutions, acids & alkali, corrosive gases and UV.
- (6) Working/Storage Temperature: $T_a: -20 \sim 60^\circ\text{C}$
- (7) 2 years warranty, life span over 36000 hours.

>> Wiring installation diagram

 end cap

 packing

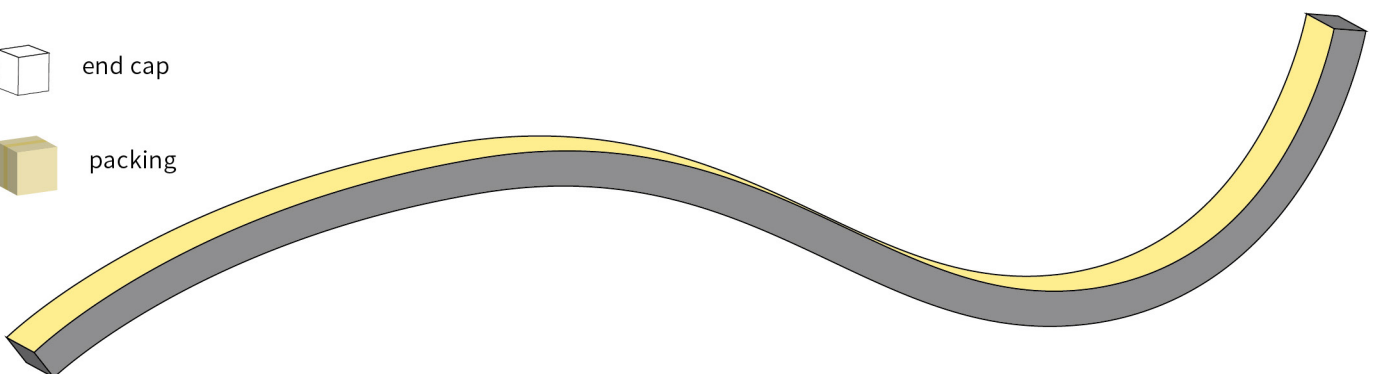



>> WIRING DIAGRAM

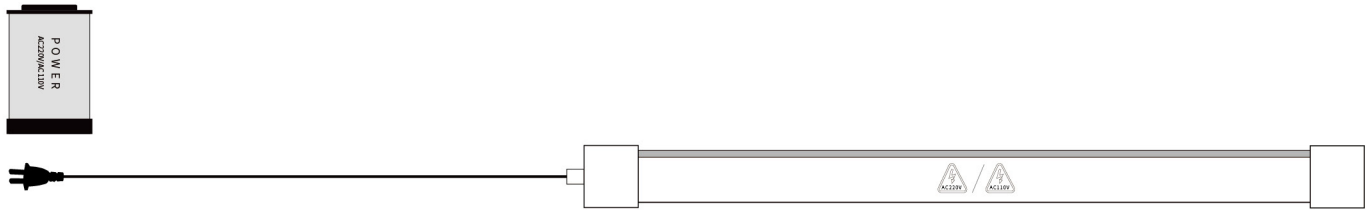

>> ACCESSORY INFORMATION

Name	Packing	Image	Net weight per box (kg)
End cap	500pcs/bag		0.01kg
End cap with hole	500pcs/bag		0.01kg
Aluminum clip	500pcs/bag		0.03kg

>> APPLICATION

Home decoration (staircase lighting, hall aisle lighting, lighting decoration, edge hook decoration)Event venue decoration, exhibition venue decoration, exhibition hall decoration, show cases window, props and other decorative lighting applications, Linear light source and other applications.

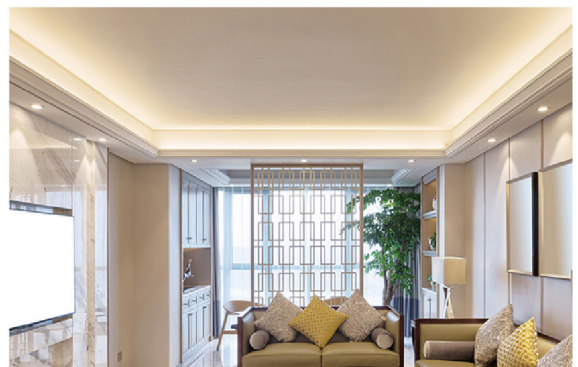



>> NOTE & WARNING

- ▲ In order to be able to better achieve the luminous effect of products, each 50 meters long lamp with a power connecting
- ▲ In order to ensure the lamp with long service life and the environment, can not force pulling the power line in these process, no collision so as not to damage the LED lamp.
- ▲ In order to ensure the lamp with life and reliability, please don't in the 100mm below diameter arc bending, not half so as not to damage the lamp or broken.
- ▲ Try to install the appropriate environment.
- ▲ Please note that careful operation, in the case of power on, don't hit the ac power, avoid shock.

>> PACKAGING

