

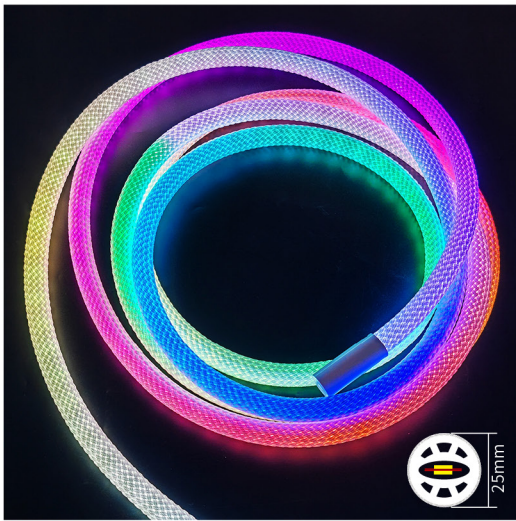

# 360° MAGIC COLOR NEON LED FLEX SPECIFICATIONS

## >> PRODUCT CHARACTER



product model	TTK-D25
Luminous Angle	360°
Product size	25mm
Voltage	DC12V/DC24V
Power	14W/Meter
LED Quantity	144Leds/m
Working temperature	-20~50°C
Waterproof Grade	IP67
Optional color	magic color
Application	Architectural contour lighting,KTV,Ceiling

## >> PRODUCT FEATURES

### 1.Luminous angle: 360°

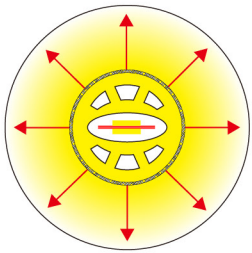

### 2.Product structure

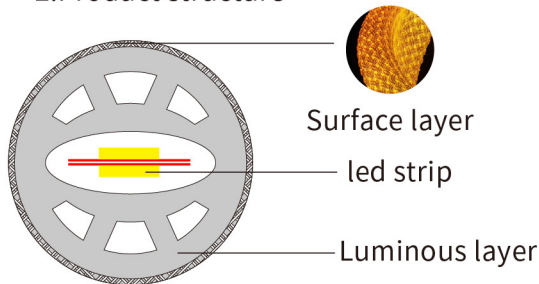

### 3.Maximum bending Angle

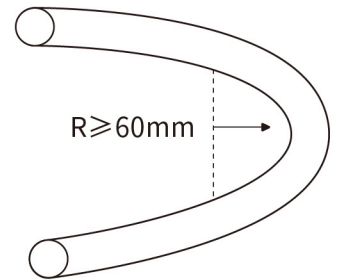

### 2.Bending direction

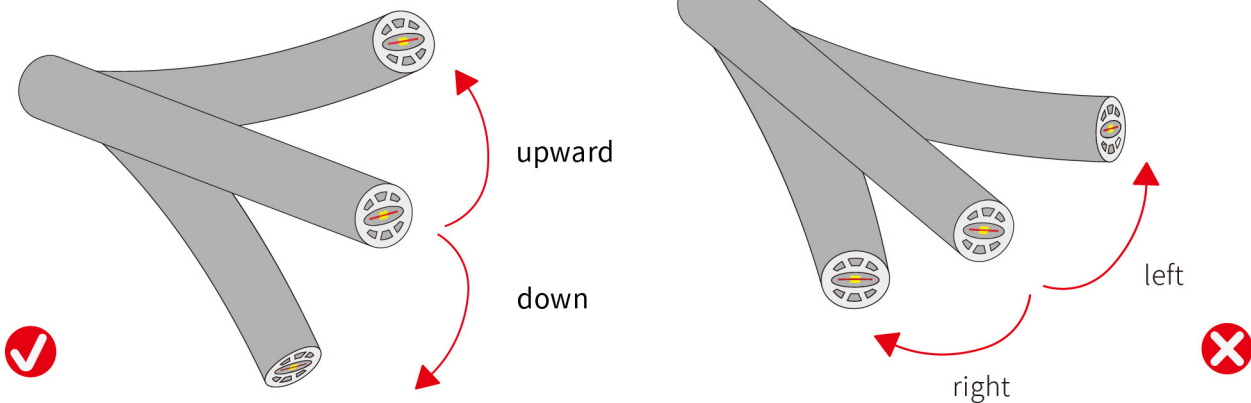



## >> BUCKLE INSTALLATION MODE

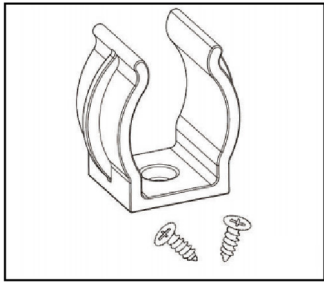

1) Prepare the screws and pc clips.

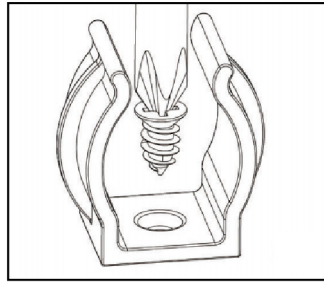

2) Adjust the pc clips to the proper position and use a screwdriver to drive the screw to secure it.

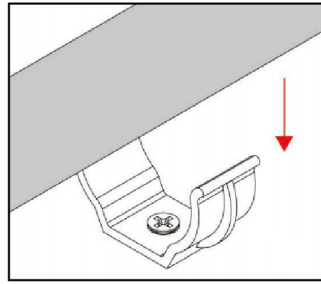

3) Open the pc clip, and put the lamp strip in a fixed position.

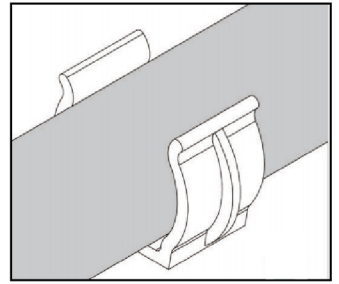

4) Installation completed

 If the length of LED strip is over 2m, it is recommended to install by two persons.

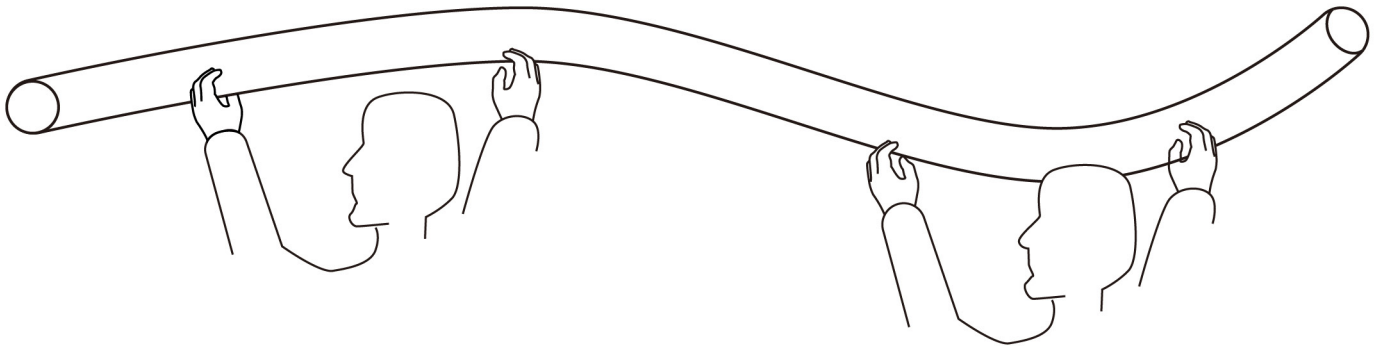

## >> FEATURES

- (1) Light source: High luminous efficiency
- (2) Professional structure design, uniform light, soft light, color temperature consistency.
- (3) Multiple modes switch to create different atmosphere effects
- (4) Increased durability :Fabric wrap can be bent to reduce the risk of breakage and other adaptations to a variety of environments.
- (5) Good softness, easy bending, easy modeling, tensile resistance .
- (6) Product Certification: CE、ROHS.
- (7) 2 years warranty, life span over 36000 hours.

## >> INSTALLATION AND ACCESSORIES

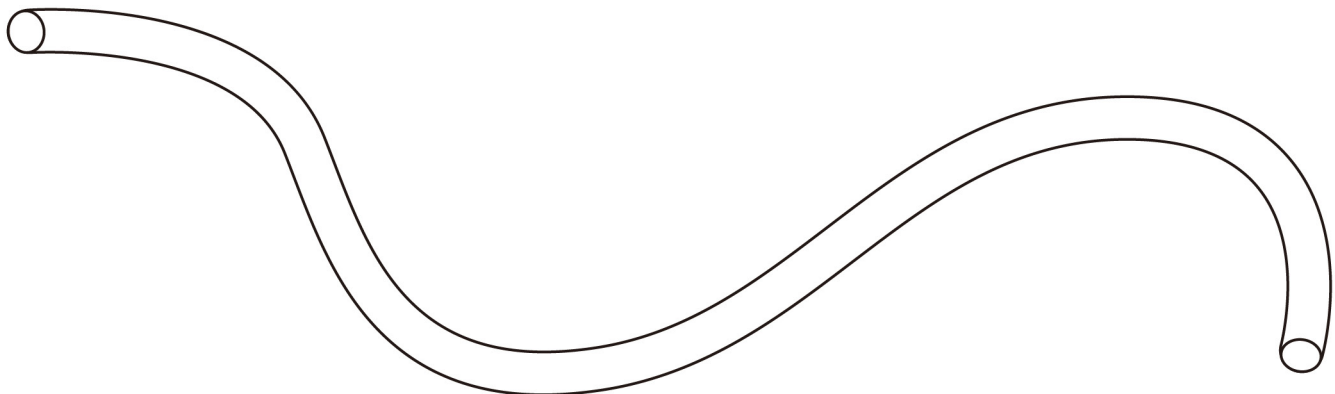



## >> WIRING DIAGRAM

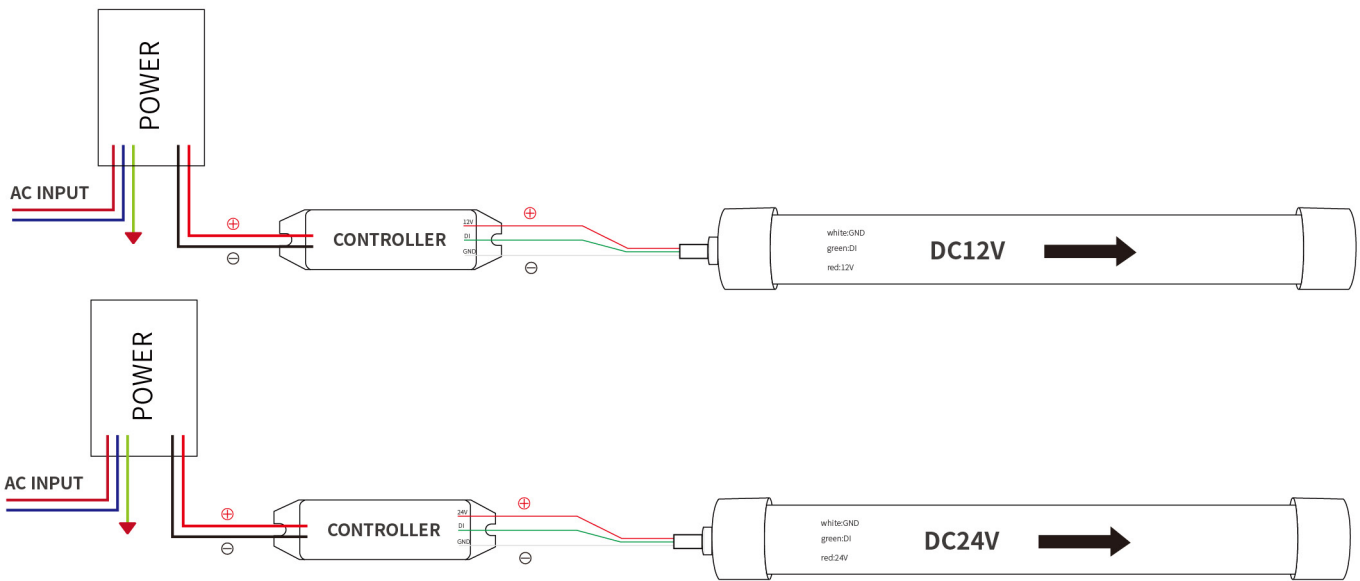

## >> ACCESSORY INFORMATION

Name	Description	Image	Sectional size	Net weight per box (kg)
end caps	Neon tube accessories		25mm 	0.01kg
Round PC clips	Fixed installation		-----	0.01kg
SP611E wifi controller	LED Controller Bluetooth & IR 8 Muslc For addressable LED		-----	0.03kg

## >> APPLICATION

Architectural contour lighting, KTV, Ceiling

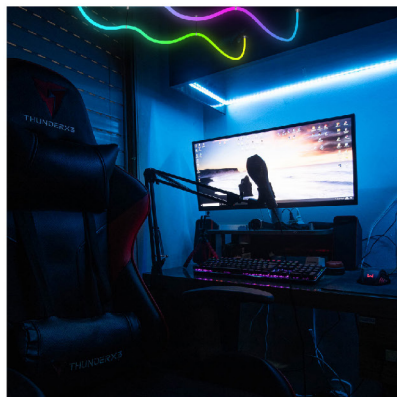
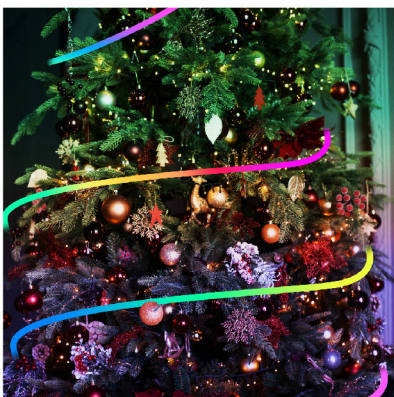



## >> NOTE & WARNING

- ▲ In order to be able to better achieve the luminous effect of products, each 5 meters or 10 meters long lamp with a power connecting.
- ▲ In order to ensure the lamp with long service life and the environment, can not force pulling the power line in these process, no collision so as not to damage the LED lamp.
- ▲ In order to ensure the lamp with life and reliability, please don't in the 60mm below diameter arc bending, not half so as not to damage the lamp or broken.
- ▲ Try to install the appropriate environment.
- ▲ Please note that careful operation, in the case of power on, don't hit the ac power, avoid shock.

## >> PACKAGING



5m/roll

