



360° RGB NEON LED FLEX SPECIFICATIONS

>> PRODUCT CHARACTER



product model	TTK-D30
Luminous Angle	360°
Voltage	DC12V/DC24V
Power	30W/Meter
Product size	30mm
CRI	≥80
Waterproof Grade	IP67
Cutting length	2.7cm/5.5cm
Optional color	RGB
Application	Signage lighting , Architectural contour lighting

>> PRODUCT FEATURES

1.LUMINOUS ANGLE: 360°

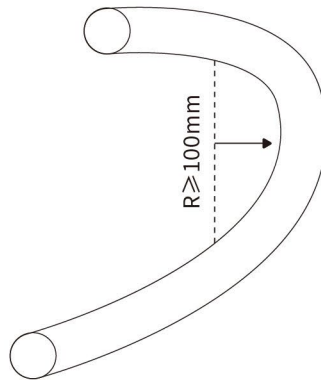
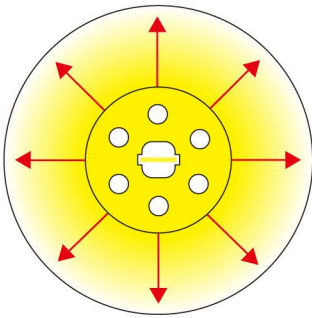

2.Bending direction

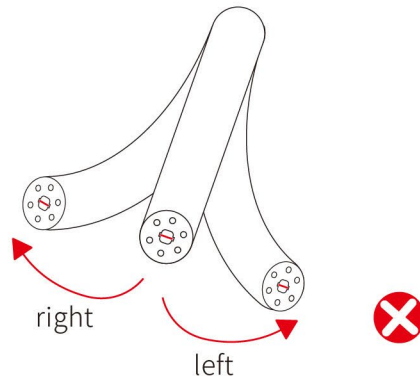
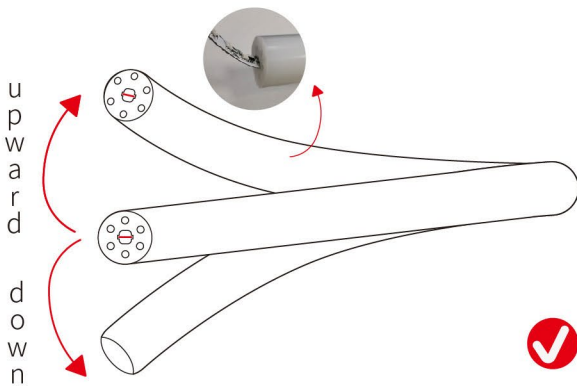



⚠ If the length of LED strip is over 2m, it is recommended to install by two persons.

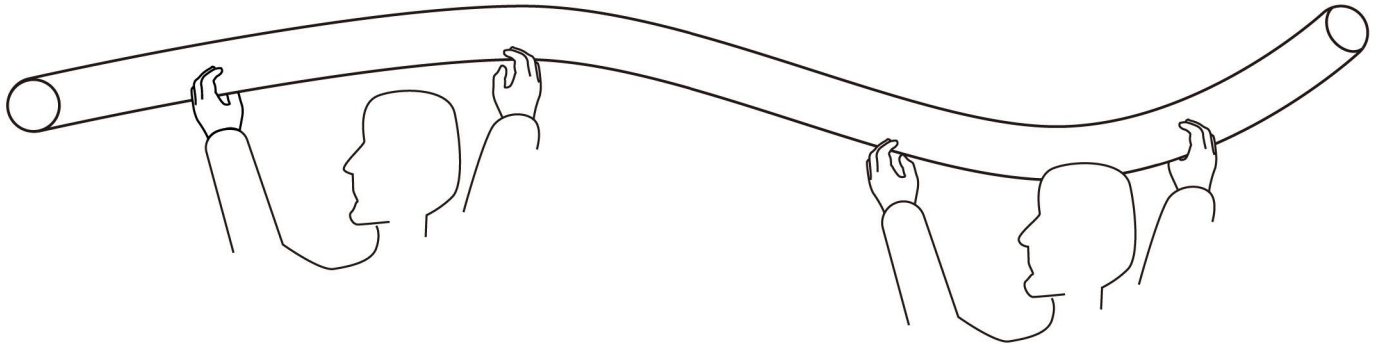

3. Features

- (1) Light source: High luminous efficiency, SMD2835, 216 LEDs/m
- (2) Process & Material: High light transmittance, environmental silicone material, integrated extrusion molding technology, IP67 waterproof.
- (3) free twist to different shape
- (4) Optical Design: Unique optical light distribution structure design, uniform lighting surface and no shadow.
- (5) Appearance Design: Compared with the traditional neon tube or PVC guardrail tube, the silicone material has good flexibility, the simple and stylish appearance, which is exquisite and unique.
- (6) Product Certification: CE, ROHS.
- (7) Environmental Features: Resistance to saline solutions, acids & alkali, corrosive gases and UV.
- (8) Working/Storage Temperature: Ta: -20~55°C / 0°C~60°C
- (9) 2 years warranty, life span over 36000 hours.

>> INSTALLATION AND ACCESSORIES

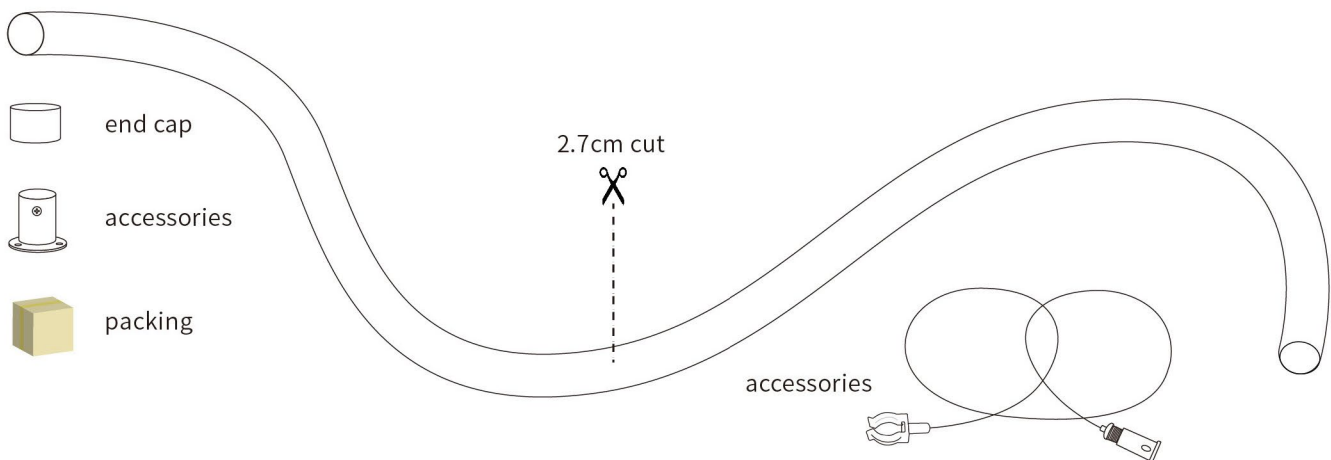



>> WIRING DIAGRAM

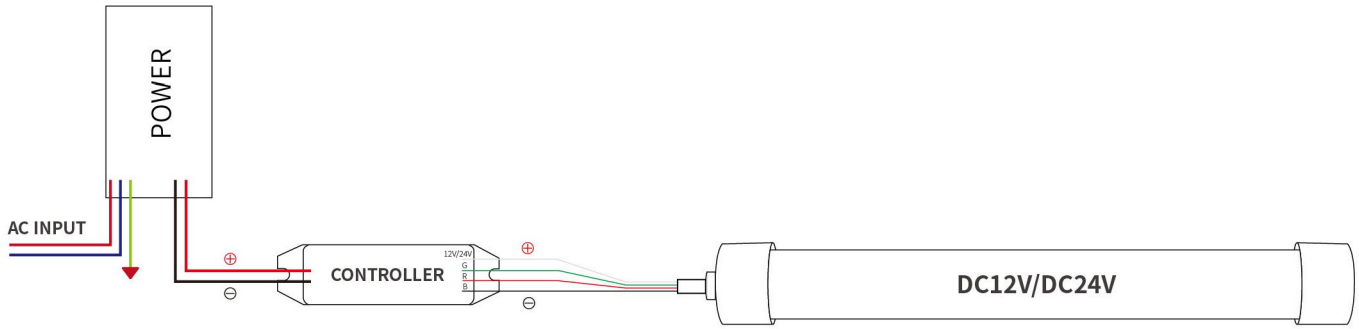

>> ACCESSORY INFORMATION

Name	Description	Image	Sectional size	Net weight per box (kg)
ceiling installation iron end cap	Fittings for ceiling mounting			0.07kg
steel rope with round PC clips	1m length of steel rope +30mm PC clips		Line length: 1000mm 	0.07kg
steel rope with round PC clips	1m length of steel rope +30mm PC clips		Line length: 1000mm 	0.07kg
green plastic anchors screws	screws for iron end cap			0.02kg
white plastic anchors screws	screws for steel rope			0.02kg
end caps without hole & with hole	neon tube accessories			0.01kg
wifi LED controller	controller+ remote		—	0.03kg



>> APPLICATION

Signage lighting , Architectural contour lighting

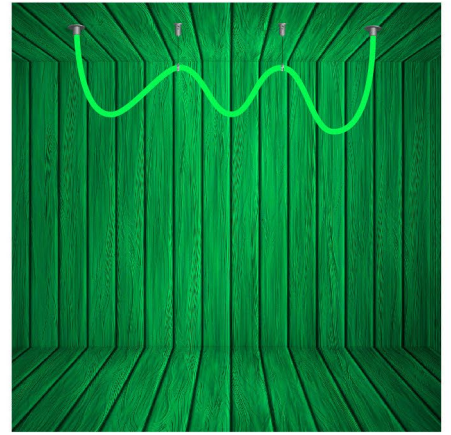
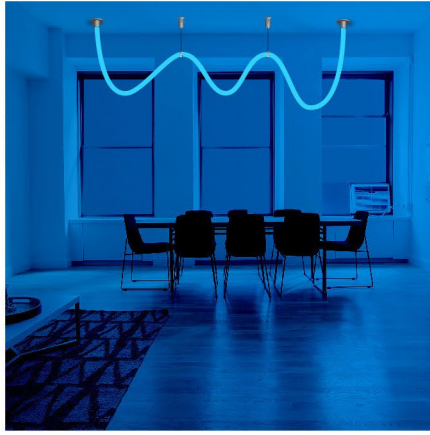

>> NOTE & WARNING

- ▲ In order to be able to better achieve the luminous effect of products, each 5 meters or 10 meters long lamp with a power connecting.
- ▲ In order to ensure the lamp with long service life and the environment, can not force pulling the power line in these process, no collision so as not to damage the LED lamp.
- ▲ In order to ensure the lamp with life and reliability, please don't in the 100mm below diameter arc bending, not half so as not to damage the lamp or broken.
- ▲ Try to install the appropriate environment.
- ▲ Please note that careful operation, in the case of power on, don't hit the ac power, avoid shock.

>> PACKAGING

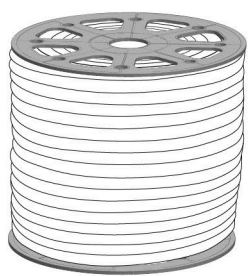

20m/roll

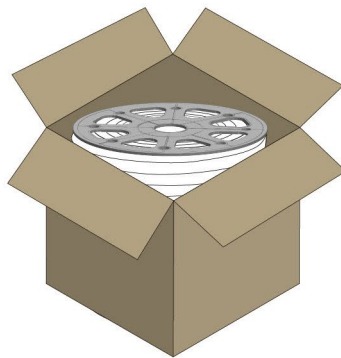

weight:13kg/box

